

DOOSAN

Construction Equipment

DX220LCA-2

Engine Power	SAE J1349, net 109 kW (148 PS) @ 1,800 rpm
Operational Weight	20,800 kg ~ 22,000 kg
Bucket Capacity (SAE/PCSA)	0.92 ~ 1.08 m ³





**SIMPLE AND ESSENTIAL,
JUST RIGHT FOR YOUR DAILY WORK**

DX220LCA-2

DX220LCA-2 delivers high productivity with outstanding fuel efficiency at a much more reasonable TCO (total cost of owning & operation) than others of the same class.

Above all, its fuel consumption per hour has been dramatically improved by up to 12%* or more against others of the same class by using quality-proven key components along with the engine, MCV and hydraulic system, which are newly developed and enhanced by Doosan technologies. It also comes with a breaker package optimized for breaker operation only and operator's seat simply designed for greater operational focus, thereby further increasing work efficiency.

* Above image may differ from actual product.

* Above result is based on internal test, against the same operation weight machine.

INTRODUCING A WHOLE NEW DX220LCA-2

DX220LCA-2

NEWLY DEVELOPED AND IMPROVED, YET STEADY AS ALWAYS,
NEW AND QUALITY-PROVEN MACHINE FOR YOUR DAILY OPERATION

KEY COMPONENTS NEWLY DEVELOPED/ENHANCED WITH DOOSAN'S TECHNOLOGIES

Doosan offers you excellent performance and durability with its own design and manufacturing technologies.

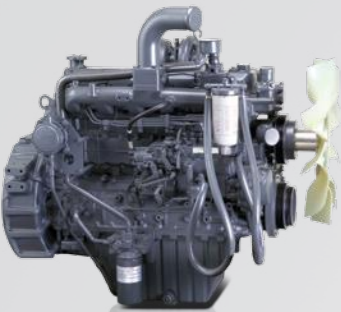

1 DB58TIS DOOSAN ENGINE

- DX220LCA-2 runs on Doosan DB58TIS engine, one of the most widely-used engines in Doosan.
- Doosan DB58TIS engine has already gained recognition in the market for reliability, low fuel consumption and easy maintenance with quality that has been validated.



2 NEW DOOSAN MCV

Manufactured with Doosan's technologies, this new version of MCV is more fuel-efficient than its previous model.

3 ENHANCEMENTS TO MAIN PUMP

This new main pump developed for DX220LCA-2 helps improve fuel economy with optimized cylinders and higher system pressures.

5 QUALITY-PROVEN, RELIABLE FRAMES AND HYDRAULIC SYSTEMS

DX220LCA-2 is built with the frames and hydraulic systems that are proven to be high quality over a long period of time. Count on us for all of your works.

Main/bottom frames, undercarriage, swing bearing, sprocket roller, boom and arm are designed for a high degree of durability that you can rely on.

* Above image may differ from actual product.



6 HEAVY-DUTY FRONT

Reinforced castings and forged steel pivot points and reinforced heavy-duty arm and boom to withstand high-impact materials.

- To better protect the base of the arm, reinforced bars have been added and the arm center and end boss have been strengthened.



Travel Device

Swing Device

Travel device, swing device and center joint are also verified for their high quality.



4 NEW DECALS

Bigger and more visible decals make DX220LCA-2 stand out anywhere of your job site.

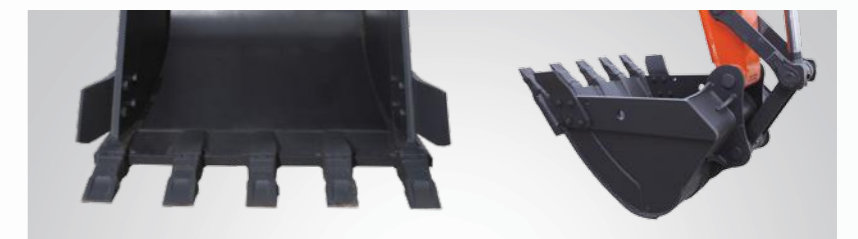

7 NEW GP (GENERAL PURPOSE) BUCKET

GP bucket installed onto DX220LCA-2 as a base spec with open type side cutters allows you to efficiently perform loading operations.



PRIDE OF DX220LCA-2, EXCELLENT WORK EFFICIENCY

DX220LCA-2

ITS FUEL CONSUMPTION AND WORK EFFICIENCY DIFFERENTIATED FROM THOSE OF THE SAME CLASS ARE THE REASONS YOU SHOULD CHOOSE DX220LCA-2.



FUEL EFFICIENCY UP UP UP!!

The enhancements to the hydraulic systems of DX220LCA-2 enable you to use engine power in a more effective manner. DX220LCA-2 is capable of performing the same intensity of operations at much lower fuel consumption than others of the same class, significantly increasing your work efficiency.

max.
12%

* Above result is based on internal test, against the same operating weight machine.

OPTIMIZED LEVER CONTROL & AUTO IDLE

When operator takes a break and leaves the control joystick fixed, both of the engine and the pump are kept in standby mode and prevents unnecessary fuel consumption.



PUMP MATCHING TECHNOLOGY

Engine & pump matching, the new technology of Doosan, fully resolves problems; low response time of the system, unnecessary fuel consumption. Matching response time between pump and engine efficiently reduces unnecessary fuel consumption as well as exhaust fumes.

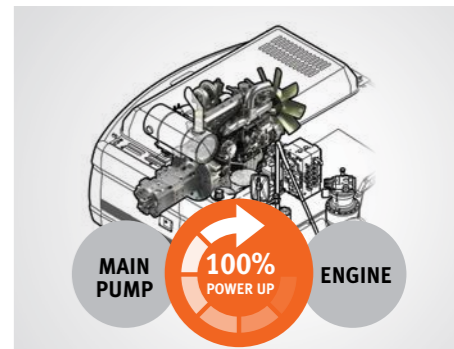

* Above image may differ from actual product.



BREAKER SYSTEM CUSTOMIZED TO YOUR BUSINESS

DX220LCA-2

DX220LCA-2 HELPS YOU PERFORM BREAKER OPERATIONS WITH A BREAKER PACKAGE OPTIMIZED FOR A GREAT NUMBER OF BREAKER OPERATIONS.



DIFFERENT TYPES OF PERFORMANCE TESTINGS, ENSURING BEST BREAKER PERFORMANCE

- Performance testings of breaker carried out at actual job sites currently being operated in Korea and overseas regions
- Throughout these testings, DX220LCA-2 comes with a breaker that is more solid and powerful than before.
- The customers who took part in these testings were "very satisfied" with the performances of all equipment.

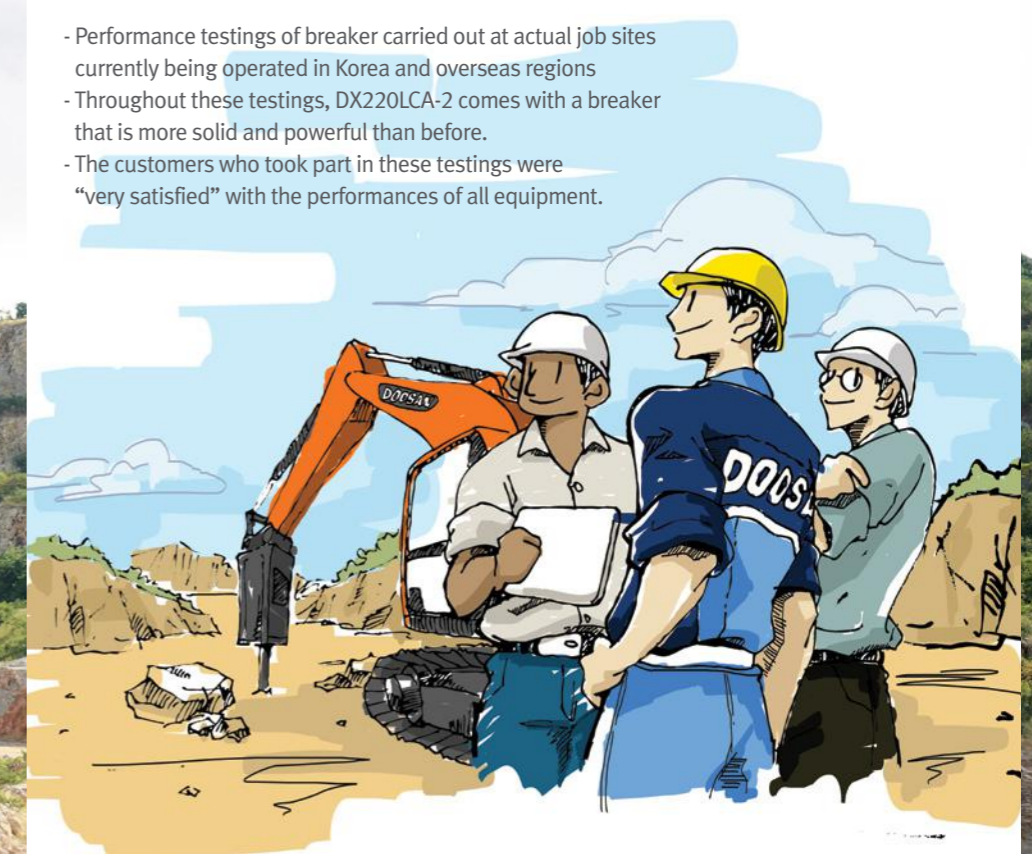

BREAKER PACKAGE (OPTION)

Do not think too much. All you need to do is to just select this breaker option.

- DX220LCA-2 is installed with a pedal tailored for breaker and a joystick with breaker-only button.

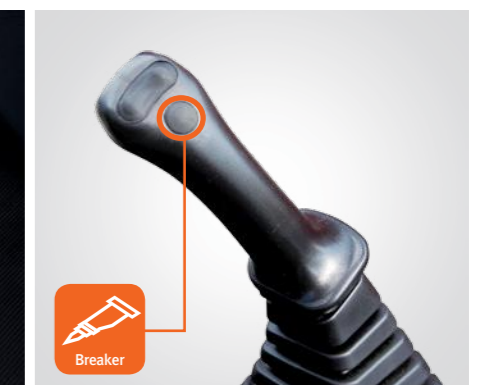

- On top of this, the breaker return line uses its own filter that will extend the life of hydraulic components during breaker operations.
- All of these features are available to you to conduct a crushing operation as effectively as you would hope.



* Above image may differ from actual product.



A SPACIOUS CABIN WITH ENHANCED COMFORT

DX220LCA-2

DX220LCA-2 COMES WITH A NEATLY DESIGNED CABIN WITH NO REDUNDANCY IN IT. YOU CAN NEVER FIND ANYTHING THAT GETS IN THE WAY OF RUNNING YOUR MACHINE. EXPERIENCE THE COMFORT OF WORKING IN A MORE SPACIOUS CABIN.



1 MONITOR

- It is not confusing and complex anymore. You can get exactly the kind of information you need to know through this new monitor at ease.
- When running your machine, it gives you the information you need most effectively with different modes as in the eco-zone mode activated for the most fuel-efficient sector, the power mode required for the most powerful operation and beyond.

COMFORTABLE JOYSTICK

With the completely redesigned joystick buttons, you can now use the most frequently used features at the tip of your fingers with this new joystick.



2

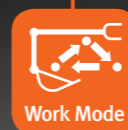

WORK MODE SELECTOR BUTTON

Breaker mode activated when this button is pushed, a indicator light in monitor turns "On"

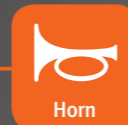

HORN BUTTON

This button is for blowing a horn

3



AUTO IDLE SELECTOR BUTTON

Auto idle system is activated when the auto idle selector button is pushed, an indicator light turns on



BREAKER OPERATING BUTTON

When this button is pushed, hydraulic flow supplied to auxiliary hydraulic line



POWER MODE SELECTOR BUTTON

This power mode is suitable for heavy duty work that requires a high operating speed. Push this button to turn power mode "ON" or "Off"

* Above image may differ from actual product.



PRIDE OF DOOSAN, DOOSAN MAINTENANCE

DX220LCA-2

ARE YOU WORRIED ABOUT YOUR MACHINE MAINTENANCE? DON'T BE. DOOSAN'S MAINTENANCE SERVICE PROGRAM IS AT YOUR SERVICE AND THIS WHOLE NEW DX220LCA-2 IS ALSO PART OF IT. TRUST DOOSAN.



We redoubled our efforts for easier maintenance.



1 PRE-CLEANER

A rotor type of pre-cleaner in DX220LCA-2 filters out particles larger than 20 microns with over 99% accuracy.



2 WATER SEPARATOR

A greater capacity of water separator helps improve engine durability.



3 ENHANCED RESERVE TANK

This new reserve tank, that is bigger in size and more effective in UV protection, has reduced failure risks.



4 GREATER COOLING CAPACITY

A larger cooling module and a longer life for your machine.



NEW VERTICAL FUEL LEVEL SENSOR

You can get more accurate information about the remaining fuel level regardless of the product positions.



HARNESS

Fixing connectors onto a certain location with excellent quality of harnesses further enhanced thermal resistance performance of the harnesses



NEW GREASE VALVE FOR IDLER CYLINDER

Separate design of injection and discharge of grease reduced a failure risk in valves.

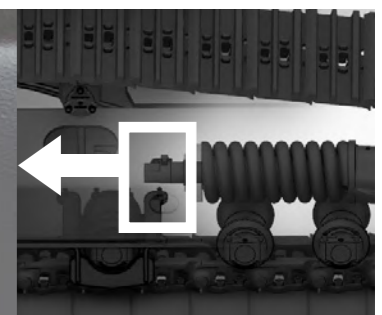

* Above image may differ from actual product.

TELEMATICS SERVICE (OPTIONAL)

GLOBAL PARTS NETWORK

TELECOMMUNICATIONS

Data flow from machine to web



TELEMATICS SERVICE TERMINAL

Telematics Service terminal is installed to machine / connected to EPOS™



TELECOMMUNICATION

GPS, EPOS™ data is sent to designated server by GSM, Satellite telecommunication



DOOSAN TELEMATICS SERVICE WEB

Doosan, Dealer, Customer can easily monitor the GPS, EPOS™ data from Core Telematics Service web

BENEFITS

JOB SITE MANAGEMENT



WORK EFFICIENCY MANAGEMENT



PREVENTIVE MAINTENANCE

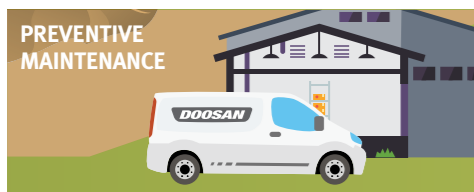

PROACTIVE SERVICE



FUNCTIONS

Location

- GPS
- Geo-fence



Operation Trend

- Total operation hour
- Operation hour by mode



Filter & Oil Management

- Preventive maintenance by item replacement cycle



Warning & Alert

- Detect machine warnings
- Antenna disconnection
- Geo/Time fence

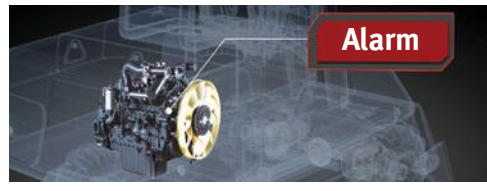

Reports

- Periodic operation report
- Utilization



Fuel Efficiency*

- Fuel level
- Fuel consumption



* Functions may not be applied to all models. Please contact your sales representative to get more information of the service.

TELEMATICS SERVICE BENEFITS

Customer

- Improve work efficiency
- Timely and preventive service
- Improve operator's skills by comparing work pattern
- Manage fleet more effectively

Dealer

- Better service for customers
- Provide better quality of service
- Maintain machine value
- Better understanding of market needs

Doosan

- Responsive to customer's voice
- Utilize quality-related field data
- Apply customer's usage profile to developing new machine

GLOBAL PDC (PARTS DISTRIBUTION CENTER) NETWORK

Doosan provides fast and precise worldwide delivery of genuine Doosan parts through its global PDC (parts distribution center) network.

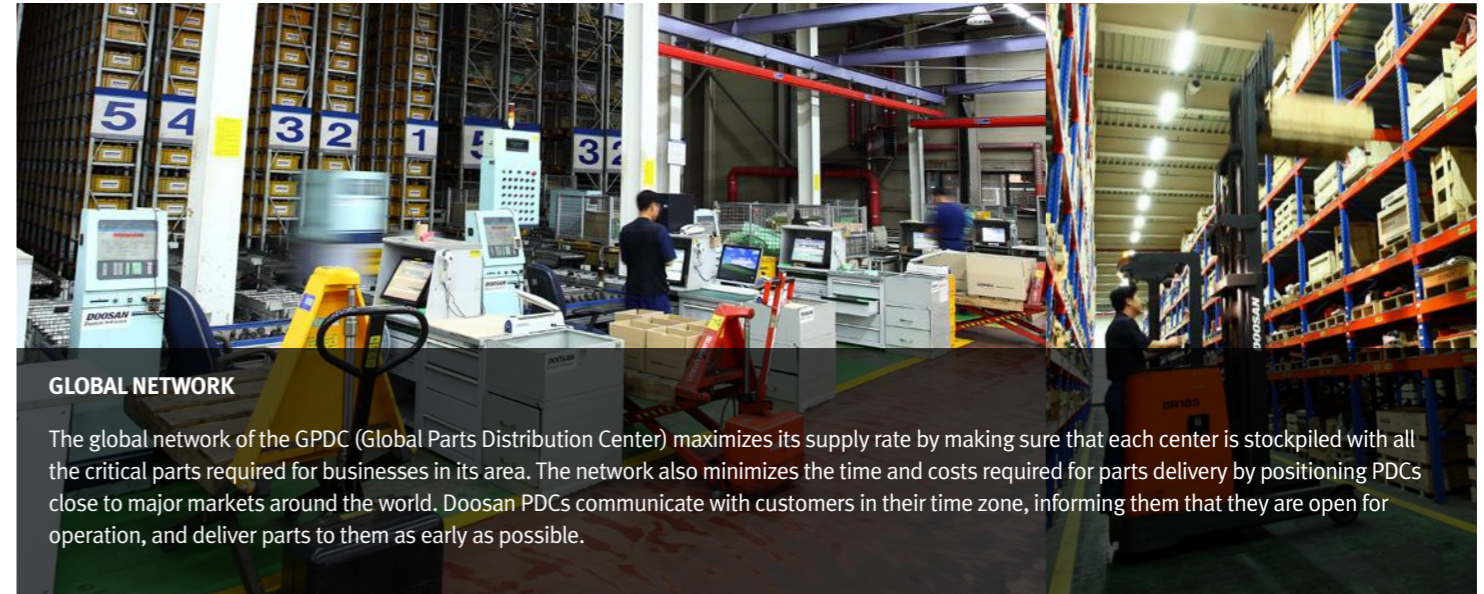

GLOBAL NETWORK

The global network of the GPDC (Global Parts Distribution Center) maximizes its supply rate by making sure that each center is stocked with all the critical parts required for businesses in its area. The network also minimizes the time and costs required for parts delivery by positioning PDCs close to major markets around the world. Doosan PDCs communicate with customers in their time zone, informing them that they are open for operation, and deliver parts to them as early as possible.

The Global Parts

Distribution Center Network

PDCs had been set up as shown below, including Mother PDC in Ansan, Korea. The eight other PDCs include one in China (Yantai), two in the USA (Chicago and Miami), one in Brazil (Campinas), two in Europe (Germany and the UK), one in the Middle East (Dubai), and one in Asia (Singapore).

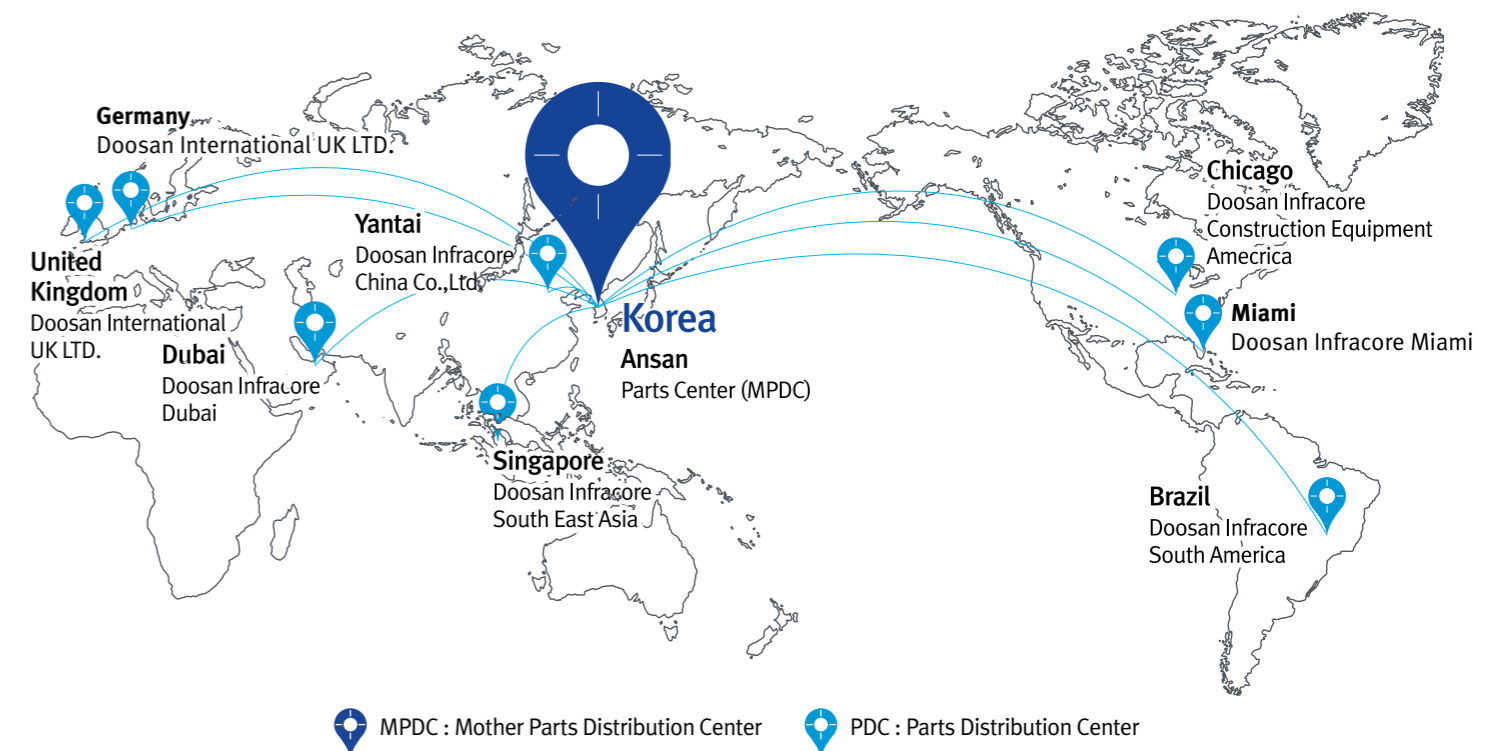

PDC BENEFIT



- Distribution Cost Reduction**
- Maximum Parts supply rate**
- Shortest distance/time parts delivery**
- Real-time service support**
- Minimum downtime**

TECHNICAL SPECIFICATIONS

ENGINE

Model
DOOSAN DB58TIS

Type
2 valves per cylinder, vertical injectors, water cooled, turbo charged with air to air intercooler. The emission levels are well below the values required for TIER II

Number of cylinders
6

RATED HORSE POWER
113 kW (154 PS) @ 1,800 rpm (SAE J1995, Gross)
109 kW (148 PS) @ 1,800 rpm (SAE J1349, net)

Max torque
66 kgf.m @ 1,400 rpm

Piston displacement
5,785cc

Bore & stroke
∅ 102 mm x 118 mm

STARTING MOTOR
24 V x 4.5 kW

Batteries
24 V (12 V x 2 / 100 AH)

Air cleaner
Double element

HYDRAULIC SYSTEM

Main pumps
Swash Plate, Axial Piston
Max. Flow : 2 x 207 l/min
Displacement : 115 X 2 cc/rev

Pilot pump
Gear pump - max flow : 27 l/min
Pilot pump : 15 cc/rev

Main relief Pressure
Maximum system pressure : 350 kgf/cm²
Main system pressure : 350kgf/cm²
Travel system pressure : 350kgf/cm²
Swing system pressure : 270kgf/cm²

HYDRAULIC CYLINDERS

The piston rods and cylinder bodies are made of high-strength steel. A shock absorbing mechanism is fitted in all cylinders to ensure shock-free operation and extend piston life.

Cylinders	Quantity	Bore x Rod diameter x stroke
Boom	2	120 X 85 X 1,263 mm
Arm	1	135 X 95 X 1,450 mm
Bucket	1	115 X 80 X 1,060 mm

UNDERCARRIAGE

Chassis are of very robust construction, all welded structures are designed to limit stresses. High-quality material used for durability. Lateral chassis welded and rigidly attached to the undercarriage. Track rollers lubricated for life, idlers and sprockets fitted with floating seals. Tracks shoes made of induction-hardened alloy with triple grousers. Heat-treated connecting pins. Hydraulic track adjuster with shock-absorbing tension mechanism.

Upper rollers - 2
Lower rollers - 8 for LC track, 7 for STD track
Track shoes - 49 for LC track, 45 for STD track
Overall track length - 4,445 mm for LC track, 4,065 mm for STD track

SWING MECHANISM

High-torque, axial piston motor with planetary reduction gear bathed in oil. Swing circle is singlerow, shear type ball bearing with induction-hardened internal gear. Internal gear and pinion gear immersed in lubricant.

Swing speed - 10.9 rpm
Swing Torque - 6.46 ton.m

DRIVE

Each track is driven by an independent, high-torque, axial piston motor through planetary reduction gear. Two levers or foot pedal control provide smooth travel or counter-rotation upon demand.

Travel speed (High / low) - 3.01 / 5.56 km/h
Maximum traction force - 22.50 / 10.28 ton
Gradeability - 70%

REFILL CAPACITIES

Fuel tank - 392 l
Cooling system - 25.6 l
Engine oil - 28 l
Swing drive - 5 l
Final drive - 2 x 3.3 l
Hydraulic tank - 131 l

WEIGHT

5.7 m Heavy Duty Boom, 2.9 m Heavy Duty Arm, 0.92 m³ Bucket, 3.8 Ton Counterweight

Shoe width (mm)	Ground pressure		Machine Weight	
	LC Track (kgf/cm ²)	STD Track (kgf/cm ²)	LC Track (Ton)	STD Track (Ton)
600	0.45	0.49	21.3	20.8
800	0.35	0.38	22.0	21.4

BUCKET LC Track, 3.8 Ton Counterweight, 600 mm Shoe

Bucket Type	Capacity (m ³) SAE/PCSA	Width (mm)		Weight (kg)	5.7 MONO Boom (HD)	
		W/O Cutter	With Cutter		2.4m Arm	2.9m Arm (HD)
GP	0.92	1,316	1,367	871	A	A
	1.05	1,458	1,509	930	A	B
H-CLASS	0.92	1,050	1,096	867	A	B
	1.08	1,200	1,246	939	B	C
	1.40	1,500	1,546	1,101	D	-
Maximum load pin-on (payload + bucket)					3,017	2,755

Based on ISO 10567 and SAE J296, arm length without quick change clamp
A : Suitable for materials with density of 2,100 kg/m³ (3,500 lb/yd³) or less
B : Suitable for materials with density of 1,800 kg/m³ (3,000 lb/yd³) or less
C : Suitable for materials with density of 1,500 kg/m³ (2,500 lb/yd³) or less
D : Suitable for materials with density of 1,200 kg/m³ (2,000 lb/yd³) or less
- : Not recommended

BUCKET DIGGING FORCES

Bucket Type	Capacity (m ³)	Width (mm)		Digging force (Ton)
	SAE/PCSA	W/O Cutter	With Cutter	
GP	0.92	1,316	1,367	[SAE] 12.6, [ISO] 14.0
	1.05	1,458	1,509	
H-Class	0.92	1,050	1,096	[SAE] 12.6, [ISO] 14.0
	1.08	1,200	1,246	
	1.40	1,500	1,546	

ARM DIGGING FORCES

Arm	Length (mm)	Weight (kg)	Digging force (Ton)
HD Arm	2,900	751	[SAE] 9.5, [ISO] 9.9
SHORT Arm	2,400	669	[SAE] 11.0, [ISO] 11.5

DIMENSIONS

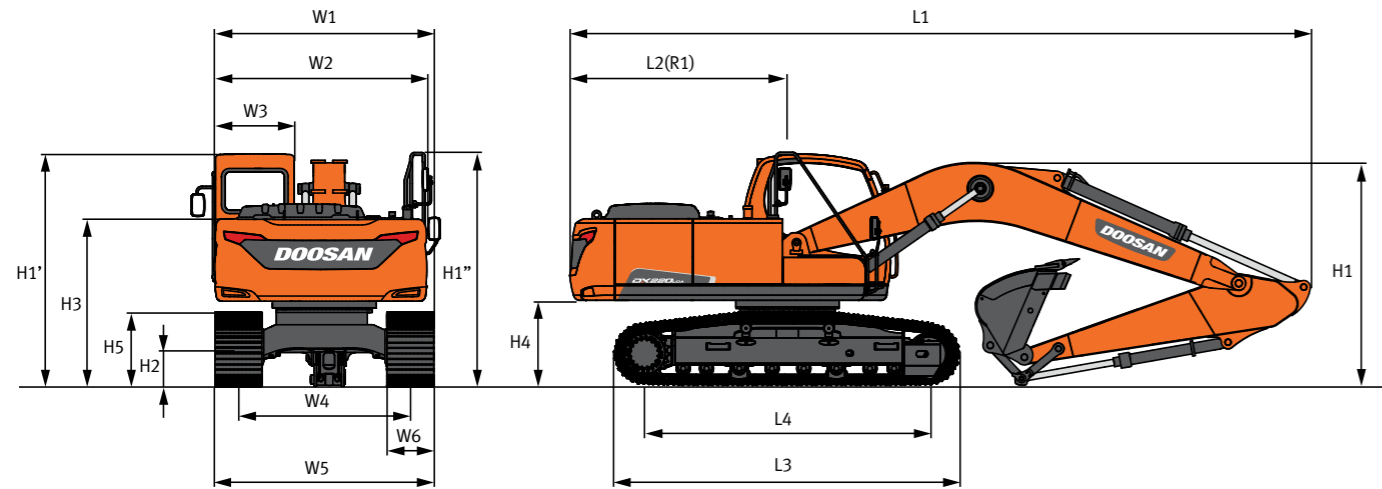

STANDARD

Boom Type		(mm)	5,700	
Arm Type		(mm)	2,900	2,400
Bucket Type (SAE/PCSA)		(m ²)	0.92	1.05
Overall Length		(mm)	L1	9,505
Overall Height	Boom	(mm)	H1	2,860
	Hose	(mm)	H1	3,005
	Cabin	(mm)	H1	2,955
	Hand/Guard Rail	(mm)	H1	2,990
Overall Width		(mm)	W1	2,990
Rear Swing Radius		(mm)	R1	2,840
Ground Clearance *		(mm)	H2	* 450.5
Rear End Distance		(mm)	L2	2,792
House Width		(mm)	W2	2,710
Cabin Width		(mm)	W3	1,010
Height Over Cover		(mm)	H3	2,113
Counterweight Clearance *		(mm)	H4	* 1,066
Track Height *		(mm)	H5	* 883
Track Length (LC Track)		(mm)	L3	4,445
Tumbler Distance (LC Track)		(mm)	L4	3,650
Track Gauge		(mm)	W4	2,390
Undercarriage Width		(mm)	W5	2,990
Shoe Width		(mm)	W6	600
Grouser Height		(mm)		26

[NOTE] *: Without Track Shoe Grouser

WORKING RANGES

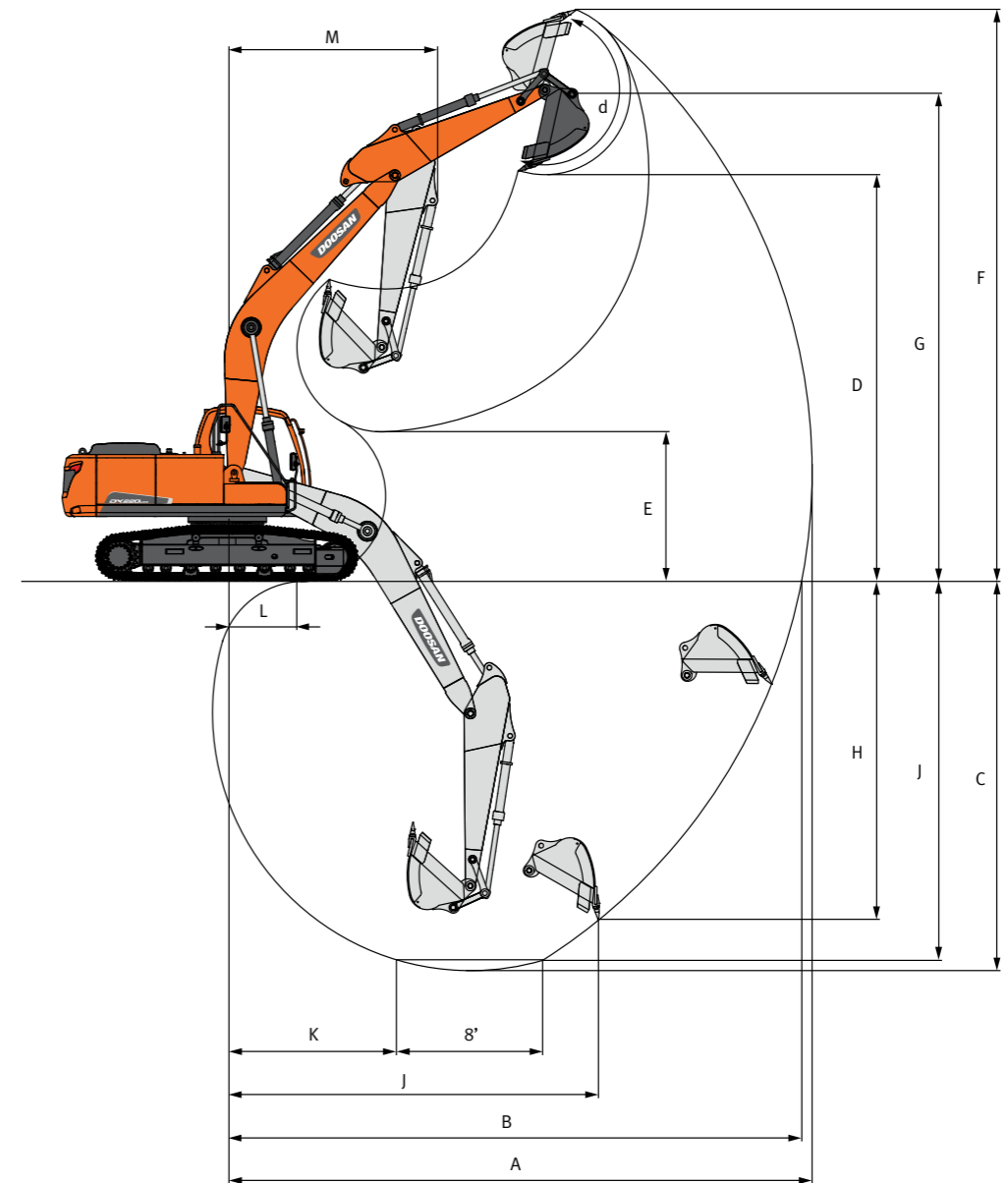

WORKING RANGES

Boom Type (One Piece)		(mm)	5,700	
Arm Type		(mm)	2,900	2,400
Bucket Type (SAE/PCSA)		(m ²)	0.92	1.05
Max. Digging Reach		(mm)	A	9,875
Max. Digging Reach (Ground)		(mm)	B	9,700
Max. Digging Depth		(mm)	C	6,595
Max. Loading Height		(mm)	D	6,840
Min. Loading Height		(mm)	E	2,500
Max. Digging Height		(mm)	F	9,625
Max. Bucket Pin Height		(mm)	G	8,280
Max. Vertical Wall Depth		(mm)	H	5,735
Max. Radius Vertical		(mm)	I	6,180
Max. Depth To 2,500mm Line		(mm)	J	6,410
Min. Radius 2,500mm Line		(mm)	K	2,860
Min. Digging Reach		(mm)	L	117
Min. Swing Radius		(mm)	M	3,555
Bucket Angle		(deg)	d	177

LIFTING CAPACITY

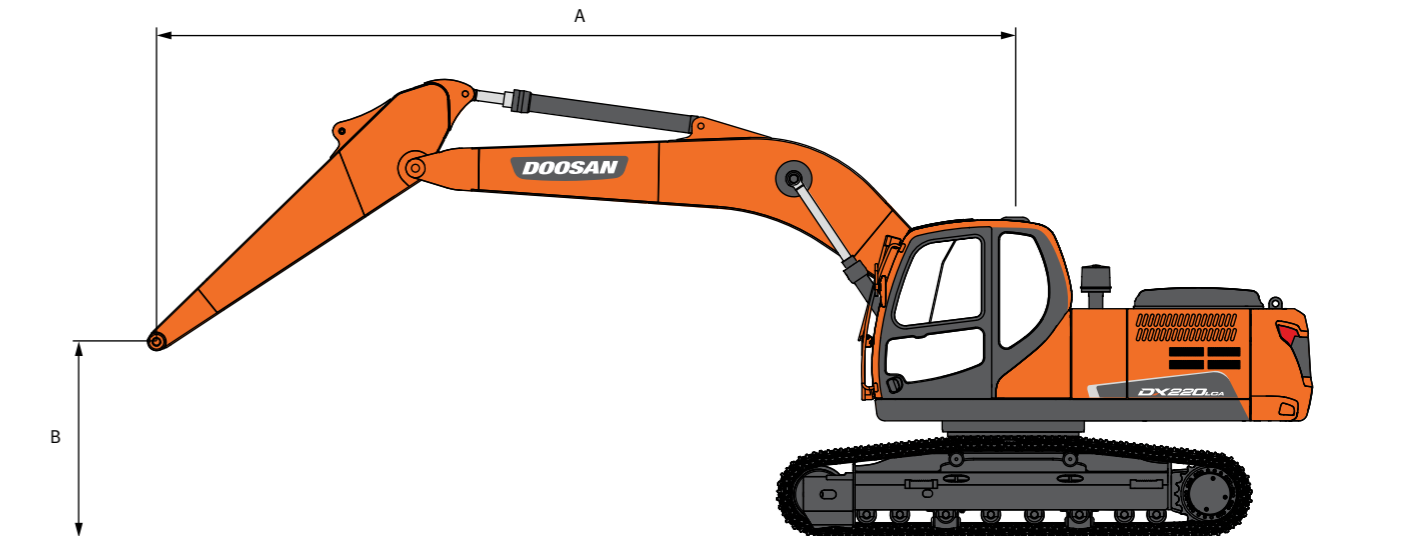
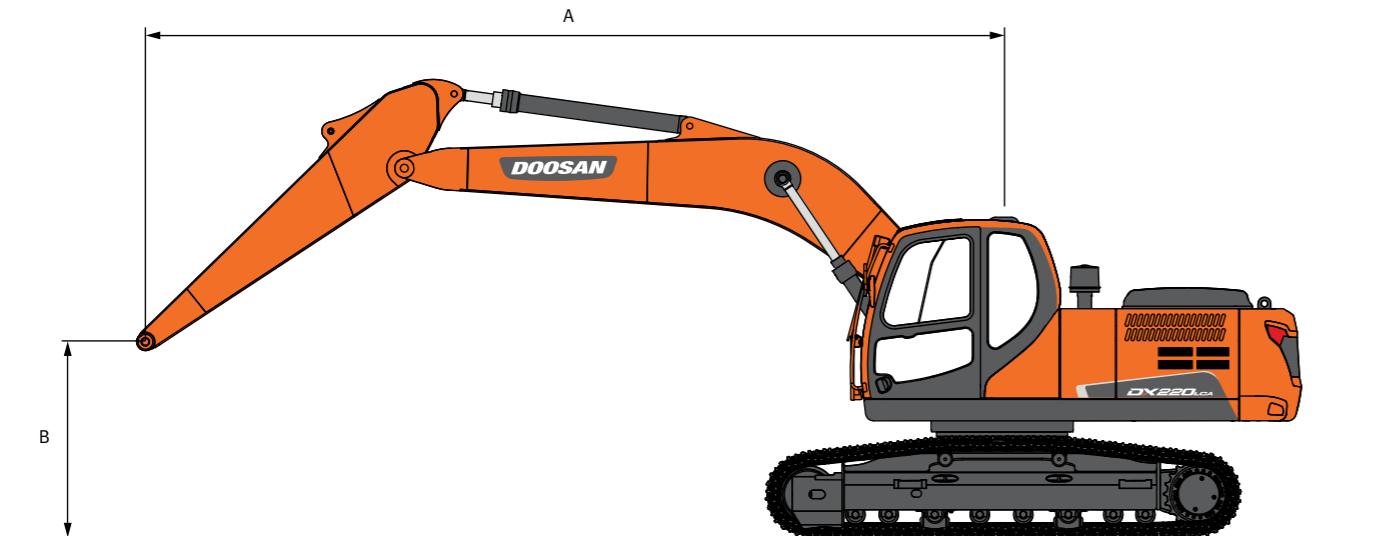

STANDARD

Metric

Boom : 5,700 mm (18' 7") Arm : 2,900 mm (9' 5") Shoe : 800 mm (2' 6") Counter Weight : 3,840 kg (8,466 lb) STD track Unit : 1,000 kg

B(m)	1.5		3		4.5		6		7.5		Max. Reach		A(m)
	☺	☹	☺	☹	☺	☹	☺	☹	☺	☹	☺	☹	
7.5							4.66 *	4.61			4.05 *	4.05 *	6.20
6							4.81 *	4.61			3.76 *	3.25	7.31
4.5							5.27 *	4.43	4.53	3.06	3.70 *	2.73	7.99
3					7.72 *	6.38	5.99 *	4.17	4.41	2.95	3.71	2.46	8.35
1.5					9.15 *	5.85	5.97	3.91	4.28	2.83	3.59	2.36	8.42
0			5.70 *	5.70 *	8.95	5.56	5.78	3.73	4.18	2.73	3.67	2.4	8.23
-1.5	6.22 *	6.22 *	9.82 *	9.82 *	8.86	5.49	5.7	3.66	4.16	2.71	3.99	2.61	7.74
-3	10.59 *	10.59 *	12.38 *	10.69	8.88 *	5.56	5.75	3.71			4.76	3.11	6.88
-4.5			9.38 *	9.38 *	6.84 *	5.81					5.20 *	4.4	5.51

Feet

Unit : 1,000 lb

B(ft)	5		10		15		20		25		Max. Reach		A(m)
	☺	☹	☺	☹	☺	☹	☺	☹	☺	☹	☺	☹	
25							10.26 *	10.16			8.92 *	8.92 *	20.33
20							10.61 *	10.16			8.29 *	7.16	23.97
15							11.61 *	9.77	10	6.75	8.16 *	6.01	26.21
10					17.02 *	14.07	13.20 *	9.19	9.73	6.51	8.18	5.43	27.39
5					20.17 *	12.89	13.17	8.62	9.44	6.23	7.92	5.21	27.64
0			12.56 *	12.56 *	19.73	12.26	12.73	8.23	9.22	6.03	8.09	5.3	26.99
-5	13.71 *	13.71 *	21.66 *	21.66 *	19.54	12.1	12.56	8.07	9.17	5.98	8.8	5.75	25.38
-10	23.34 *	23.34 *	27.29 *	23.57	19.58 *	12.26	12.67	8.17			10.49	6.86	22.59
-15			20.68 *	20.68 *	15.09 *	12.81					11.46 *	9.71	18.07

1. Load point is the end of the arm.
2. Capacities marked with an asterisk (*) are limited by hydraulic capacities.
3. Lift capacities shown do not exceed 75 % of minimum tipping loads or 87 % of hydraulic capacities.
4. The least stable position is over the side.
5. Lift capacities apply only to the machine as originally manufactured and normally equipped by the manufacturer.
6. Lift capacities are in compliance with iso 10567.

☺ : Rating Over Front
☹ : Rating Over Side or 360 Degree

OPTION

Metric

Boom : 5,700 mm (18' 7") Arm : 2,900 mm (9' 5") Shoe : 600 mm (2' 0") Counter Weight : 3,840 kg (8,466 lb) LC track Unit : 1,000 kg

B(m)	1.5		3		4.5		6		7.5		Max. Reach		A(m)
	☺	☹	☺	☹	☺	☹	☺	☹	☺	☹	☺	☹	
7.5							4.66 *	4.66 *			4.05 *	4.05 *	6.20
6							4.81 *	4.81 *			3.76 *	3.53	7.31
4.5							5.27 *	4.81	4.85 *	3.33	3.70 *	2.97	7.99
3					7.72 *	7	5.99 *	4.54	4.98	3.22	3.80 *	2.69	8.35
1.5					9.15 *	6.45	6.71 *	4.28	4.85	3.09	4.05 *	2.59	8.42
0			5.70 *	5.70 *	9.83 *	6.15	6.61	4.1	4.74	3	4.15	2.63	8.23
-1.5	6.22 *	6.22 *	9.82 *	9.82 *	9.74 *	6.08	6.53	4.03	4.72	2.98	4.52	2.86	7.74
-3	10.59 *	10.59 *	12.38 *	12.09	8.88 *	6.16	6.58 *	4.07			5.38 *	3.41	6.88
-4.5			9.38 *	9.38 *	6.84 *	6.41					5.20 *	4.83	5.51

Feet

Unit : 1,000 lb

B(ft)	5		10		15		20		25		Max. Reach		A(m)
	☺	☹	☺	☹	☺	☹	☺	☹	☺	☹	☺	☹	
25							10.26 *	10.26 *			8.92 *	8.92 *	20.33
20							10.61 *	10.61 *			8.29 *	7.78	23.97
15							11.61 *	10.61	10.70 *	7.34	8.16 *	6.55	26.21
10					17.02 *	15.43	13.20 *	10.02	10.99	7.09	8.37 *	5.94	27.39
5					20.17 *	14.22	14.79 *	9.44	10.68	6.82	8.92 *	5.71	27.64
0			12.56 *	12.56 *	21.68 *	13.57	14.57	9.04	10.46	6.61	9.15	5.81	26.99
-5	13.71 *	13.71 *	21.66 *	21.66 *	21.47 *	13.4	14.39	8.88	10.4	6.56	9.97	6.31	25.38
-10	23.34 *	23.34 *	27.29 *	26.64	19.58 *	13.57	14.51 *	8.98			11.85 *	7.52	22.59
-15			20.68 *	20.68 *	15.09 *	14.13					11.46 *	10.64	18.07

1. Load point is the end of the arm.
2. Capacities marked with an asterisk (*) are limited by hydraulic capacities.
3. Lift capacities shown do not exceed 75 % of minimum tipping loads or 87 % of hydraulic capacities.
4. The least stable position is over the side.
5. Lift capacities apply only to the machine as originally manufactured and normally equipped by the manufacturer.
6. Lift capacities are in compliance with iso 10567.

☺ : Rating Over Front
☹ : Rating Over Side or 360 Degree

STANDARD & OPTION

STANDARD EQUIPMENT

Fronts

- 5.9 m Heavy Duty Boom
- 2.9 m Heavy Duty Arm

Hydraulic system

- Boom and Arm flow regeneration
- Boom and Arm holding valves
- Swing anti-rebound valves

Cabin & Interior

- Viscous cab mounts
- E/G RPM control dial
- Serial communication port for laptop PC interface
- Cup holder
- Seat belt
- 12V spare power socket
- Room light
- All weather sound suppressed type CAB.
- Viscous cab mounts

Safety

- Handrail and step
- Safety glass
- Hammer for emergency escape
- Battery protector cover

Others

- Double element air cleaner with two stage filtration
- Dry type Pre Air Cleaner
- Two stage water separator
- Fuel filter
- Engine overheat prevention system
- Engine restart prevention system
- Self-diagnostic system
- Alternator (24 V, 60 A)
- Electric horn
- Working lights (1 boom mounted, 1 storage box mounted)
- Hydraulic track adjuster
- Track guards
- Greased and sealed track link
- Hydraulic oil tank air breather filter

OPTIONAL EQUIPMENT

Some of optional equipments may be standard in some markets. Some of this optional equipment is not available in some markets. You must check with the local DOOSAN dealer to know about the availability or to release the adaptation following the needs of the applications

Arm

- 2.4m Mass Excavation Arm

Bucket

- 0.92 m³ General Duty Bucket
- 1.05 m³ General Duty Bucket
- 0.92 m³ H Class Bucket
- 1.08 m³ H Class Bucket
- 1.4 m³ H Class Bucket

Auxiliary Hydraulic

- One-way for Hammer
- Hydraulic Filter for One-way return line

Undercarriage

- Long & Fixed Track
- Standard & Fixed Track
- Undercover for Track Frame
- 600 mm / 700 mm / 800 mm Triple Grouser Shoe

Cabin Sub Group

- Mechanical type Suspension Seat
- Upper and Lower Guard
- Side Mirror
- 2 Working lamp
- Wiper
- MP3 Radio
- Air Conditioner and Heater
- TMS (Doosan Telematics System)

DOOSAN HB Breaker

HB series Breaker is designed for mainly focusing on breaking job. Doosan's focus is to optimize impact power, enhance durability, satisfy customer convenience and maintain easily in order to be faithful to the original function of hydraulic breaker.



* Housing / Top / Side type bracket are available

Technical Specification

Model	Weight [kg]	Tool dia. [mm]	Oil Flow [l/min]	Operating Pressure [kg/cm ²]	Frequency [bpm]
HB20	1,860	135	130 ~ 150	160 ~ 200	400 ~ 800

Doosan is

Since 1896, Doosan, the oldest company in Korea, has evolved with its people. The company grew up rapidly for last 10 years with reputation. For human-oriented vision, Doosan has been building constructions, energy, machines, infra structures globally. As a global leader of infra structure, Doosan continues its vision to make human-oriented future.

First in Korea, Doosan self-developed excavators in 1985 and continued building versatile construction machines including excavators, wheel loaders, articulated dump trucks to execute its human-oriented philosophy. Doosan became a global leader of heavy construction machine industry by achieving global sales line, producing line, and distribution line. Along with large production bases in Korea, China, USA, Czech, Brazil, Doosan has 1400 dealer networks and Doosan is providing reliable products and trusted solutions for your stable business at no risk.



Doosan Infracore Korea Office (HQ)
27F, Doosan Tower, 275, Jangchungdan-ro,
Jung-gu, Seoul, Korea(04563)
www.doosaninfracore.com/ce/

Copyright 2017. Doosan Infracore. All rights reserved.